

RIGOL

快速指南

MSO4000/DS4000 系列数字示波器

2014 年 2 月

RIGOL Technologies, Inc.

Guaranty and Declaration

Copyright

© 2013 RIGOL Technologies, Inc. All Rights Reserved.

Trademark Information

RIGOL is a registered trademark of RIGOL Technologies, Inc.

Publication Number

QGA15103-1110

Notices

- **RIGOL** products are protected by patent law in and outside of P.R.C.
- **RIGOL** reserves the right to modify or change parts of or all the specifications and pricing policies at company's sole decision.
- Information in this publication replaces all previously corresponding materials.
- **RIGOL** shall not be liable for losses caused by either incidental or consequential in connection with the furnishing, use or performance of this manual as well as any information contained.
- Any part of this document is forbidden to be copied or photocopied or rearranged without prior written approval of **RIGOL**.

Product Certification

RIGOL guarantees this product conforms to the national and industrial standards in China as well as the ISO9001:2008 standard and the ISO14001:2004 standard. Other international standard conformance certification is in progress.

Contact Us

If you have any problem or requirement when using our products or this manual, please contact **RIGOL**.

E-mail: service@rigol.com

Website: www.rigol.com

Safety Requirement

General Safety Summary

Please review the following safety precautions carefully before putting the instrument into operation so as to avoid any personal injuries or damages to the instrument and any product connected to it. To prevent potential hazards, please use the instrument only specified by this manual.

Use Proper Power Cord.

Only the power cord designed for the instrument and authorized by local country could be used.

Ground The Instrument.

The instrument is grounded through the Protective Earth lead of the power cord. To avoid electric shock, it is essential to connect the earth terminal of power cord to the Protective Earth terminal before any inputs or outputs.

Connect the Probe Correctly.

Do not connect the ground lead to high voltage since it has the isobaric electric potential as ground.

Observe All Terminal Ratings.

To avoid fire or shock hazard, observe all ratings and markers on the instrument and check your manual for more information about ratings before connecting.

Use Proper Overvoltage Protection.

Make sure that no overvoltage (such as that caused by a thunderstorm) can reach the product, or else the operator might expose to danger of electrical shock.

Do Not Operate Without Covers.

Do not operate the instrument with covers or panels removed.

Avoid Circuit or Wire Exposure.

Do not touch exposed junctions and components when the unit is powered.

Do Not Operate With Suspected Failures.

If you suspect damage occurs to the instrument, have it inspected by qualified service personnel before further operations. Any maintenance, adjustment or replacement especially to circuits or accessories must be performed by **RIGOL** authorized personnel.

Keep Well Ventilation.

Inadequate ventilation may cause increasing of temperature or damages to the device. So please keep well ventilated and inspect the intake and fan regularly.

Do Not Operate in Wet Conditions.

In order to avoid short circuiting to the interior of the device or electric shock, please do not

operate in a humid environment.

Do Not Operate in an Explosive Atmosphere.

In order to avoid damages to the device or personal injuries, it is important to operate the device away from an explosive atmosphere.

Keep Product Surfaces Clean and Dry.

To avoid the influence of dust and/or moisture in air, please keep the surface of device clean and dry.

Electrostatic Prevention.

Operate in an electrostatic discharge protective area environment to avoid damages induced by static discharges. Always ground both the internal and external conductors of the cable to release static before connecting.

Handling Safety.

Please handle with care during transportation to avoid damages to buttons, knob interfaces and other parts on the panels.

Safety Terms and Symbols

Terms in this Manual. The following terms may appear in this manual:



WARNING

Warning statements indicate the conditions or practices that could result in injuries or loss of life.



CAUTION

Caution statements indicate the conditions or practices that could result in damage to this product or loss of data.

Terms on the Product. The following terms may appear on the product:

DANGER indicates an injury or hazard may immediately happen.

WARNING indicates an injury or hazard may be accessible potentially.

CAUTION indicates a potential damage to the instrument or other property might occur.

Symbols on the Product. The following symbols may appear on the product:



**Hazardous
Voltage**



Safety Warning



**Protective
Earth
Terminal**



**Chassis
Ground**



**Test
Ground**

Measurement Category

Measurement Category

MSO4000/DS4000 series digital oscilloscopes can make measurements in Measurement Category I.



WARNING

This oscilloscope can only be used for measurements within its specified measurement categories.

Measurement Category Definitions

Measurement category I is for measurements performed on circuits not directly connected to MAINS. Examples are measurements on circuits not derived from MAINS, and specially protected (internal) MAINS derived circuits. In the latter case, transient stresses are variable; for that reason, the transient withstand capability of the equipment is made known to the user.

Measurement category II is for measurements performed on circuits directly connected to the low voltage installation. Examples are measurements on household appliances, portable tools and similar equipment.

Measurement category III is for measurements performed in the building installation. Examples are measurements on distribution boards, circuit-breakers, wiring, including cables, bus-bars, junction boxes, switches, socket-outlets in the fixed installation, and equipment for industrial use and some other equipment, for example. Stationary motors with permanent connection to the fixed installation.

Measurement category IV is for measurements performed at the source of the low-voltage installation. Examples are electricity meters and measurements on primary overcurrent protection devices and ripple control units.

Ventilation Requirement

This oscilloscope uses fan to force cooling. Please make sure that the air intake and exhaust areas are free from obstructions and have free air. When using the oscilloscope in a bench-top setting, provide at least 10 cm clearance beside, above and behind the instrument for adequate ventilation.



WARNING

Inadequate ventilation may cause temperature increase which would damage the instrument. So please keep the instrument well ventilated during operation and inspect the intake and fan regularly.

Working Environment

Temperature

Operating: 0°C to +50°C

Non-operating: -40°C to +70°C

Humidity

0°C to +30°C: ≤95% relative humidity

+30°C to +40°C: ≤75% relative humidity

+40°C to +50°C: ≤45% relative humidity



WARNING

To avoid short circuit inside the instrument or electric shock, please do not operate in humid environment.

Altitude

Operating: less than 3 km

Non-operating: less than 15 km

Installation (overvoltage) Category

This product is powered by MAINS conforming to installation (overvoltage) category II.

**WARNING**

Make sure that no overvoltage (such as that caused by thunderbolt) can reach the product, or else the operator might expose to danger of electric shock.

Installation (overvoltage) Category Definitions

Installation (overvoltage) category I refers to signal level which is applicable to equipment measurement terminals connected to the source circuit. In these terminals, precautions are done to limit the transient voltage to the corresponding low level.

Installation (overvoltage) category II refers to the local power distribution level which is applicable to equipment connected to the AC line (AC power).

Pollution Degree

Degree 2

Pollution Degree Definitions

Pollution degree 1: No pollution or only dry, non-conductive pollution occurs. The pollution has no influence. For example: a clean room or air-conditioned office environment.

Pollution degree 2: Normally only dry, non-conductive pollution occurs. Occasionally a temporary conductivity caused by condensation may occur. For example: general indoor environment.

Pollution degree 3: Conductive pollution occurs, or dry, non-conductive pollution occurs which becomes conductive due to condensation which is expected. For example: Sheltered outdoor environment.

Pollution degree 4: Pollution that generates persistent conductivity through conductive dust, rain, or snow. For example: outdoor locations.

Safety Class

Class 1 – Grounded Product

General Care and Cleaning

General Care:

Do not store or leave the instrument in where the instrument will be exposed to direct sunlight for long periods of time.

Cleaning:

Clean the instrument regularly according to its operating conditions. To clean the exterior surface, perform the following steps:

1. Disconnect the instrument from all power sources.
2. Clean the loose dust on the outside of the instrument with a lint- free cloth (with a mild detergent or water). When cleaning the LCD, take care to avoid scarifying it.

**CAUTION**

To avoid damages to the instrument, do not expose them to liquids which have causticity.

**WARNING**

To avoid injury resulting from short circuit, make sure the instrument is completely dry before reconnecting to a power source.

Environmental Considerations

The following symbol indicates that this product complies with the requirements of European Union according to Directives 2002/96/EC on waste electrical and electronic equipment (WEEE).

**Product End-of-Life Handling**

The equipment may contain substances that could be harmful to the environment or human health. In order to avoid release of such substances into the environment and harm to human health, we encourage you to recycle this product in an appropriate system that will ensure that most of the materials are reused or recycled appropriately. Please contact your local authorities for disposal or recycling information.

Contents

Guaranty and Declaration	I
Safety Requirement	II
General Safety Summary	II
Safety Terms and Symbols	III
Measurement Category	IV
Ventilation Requirement	V
Working Environment	V
General Care and Cleaning	VI
Environmental Considerations	VII
Quick Start	1
General Inspection	1
Appearance and Dimensions	2
To Prepare for Operation	3
To Remove the Cover	3
To Adjust the Supporting Legs	3
To Connect to AC Power Supply	4
Power-on Inspection	4
To Connect the Probe	5
Function Inspection	5
Probe Compensation	7
To Connect the Logic Probe	7
Front Panel Overview	8
Rear Panel Overview	9
Front Panel Function Overview	11
VERTICAL	11
HORIZONTAL	12
TRIGGER	13
CLEAR	13
AUTO	14
RUN/STOP	14
SINGLE	14
Knob	15
Navigation Knob	15
Default	16
Print	16
Function Keys	16
Record	17
LOGIC ANALYZER	18
User Interface	19
To Use the Security Lock	23
To Use the Built-in Help System	24
Troubleshooting	25

Quick Start

General Inspection

1. **Inspect the shipping container for damage**

Keep the damaged shipping container or cushioning material until the contents of the shipment have been checked for completeness and the instrument has passed both electrical and mechanical tests.

The consigner or carrier shall be liable for the damage to instrument resulting from shipment. **RIGOL** would not be responsible for free maintenance/rework or replacement of the unit.

2. **Inspect the instrument**

In case of any damage, or defect, or failure, notify your **RIGOL** sales representative.

3. **Check the accessories**

Please check the accessories according to the packing lists. If the accessories are incomplete or damaged, please contact your **RIGOL** sales representative.

Appearance and Dimensions

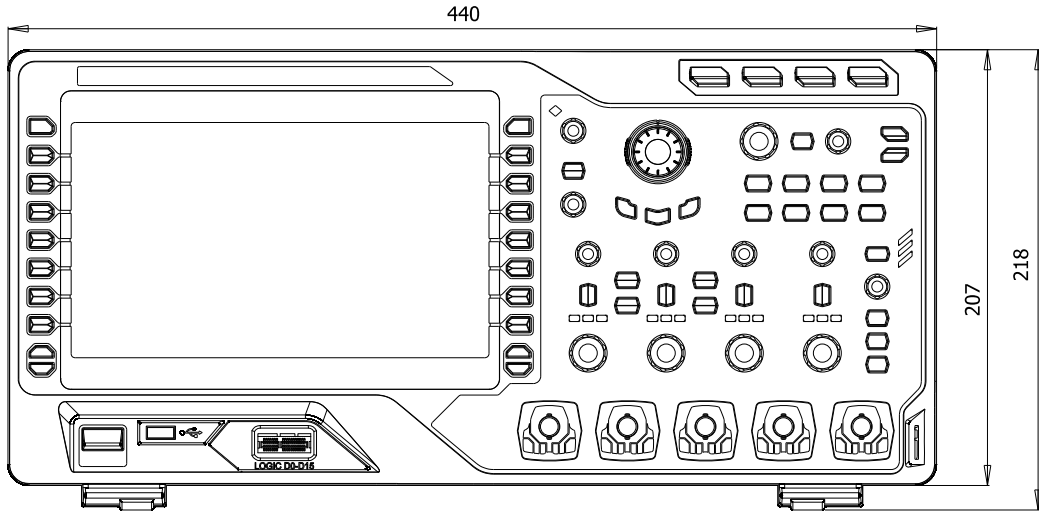

Figure 1 Front View

Unit: mm

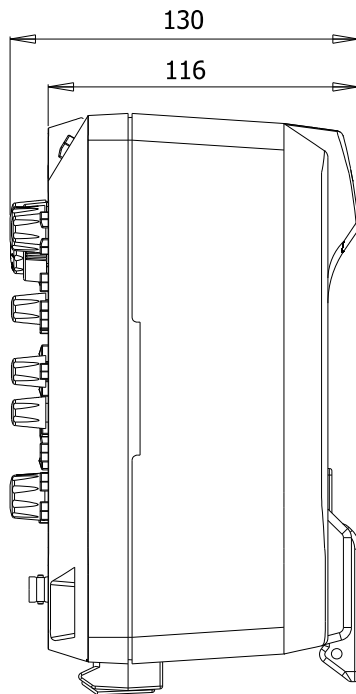

Figure 2 Side View

Unit: mm

To Prepare for Operation

To Remove the Cover

Before using the oscilloscope, remove the front panel cover by grasping the transverse grab on each side and pull them in the arrow directions as shown in the figure below.

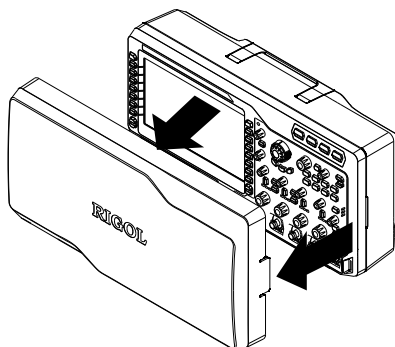

Figure 3 To Remove the Cover

To Adjust the Supporting Legs

Adjust the supporting legs properly to use them as stands to tilt the oscilloscope upwards, thus to place the oscilloscope stably and to operate and observe the display better. You can unfold or fold the supporting legs in the arrow directions as shown in the figure below.

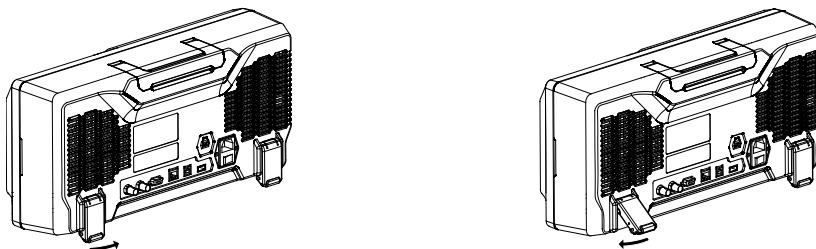



Figure 4 To Adjust the Supporting Legs

To Connect to AC Power Supply

This oscilloscope accepts two kinds of AC power supplies: 100-127V, 45-440Hz and 100-240V, 45-65Hz. Please use the power cord supplied with the accessories to connect the oscilloscope to the power source. Turn on the power switch under the power plug; at this point, the oscilloscope is energized and the power key  at the lower-left corner of the front panel is in breath state.

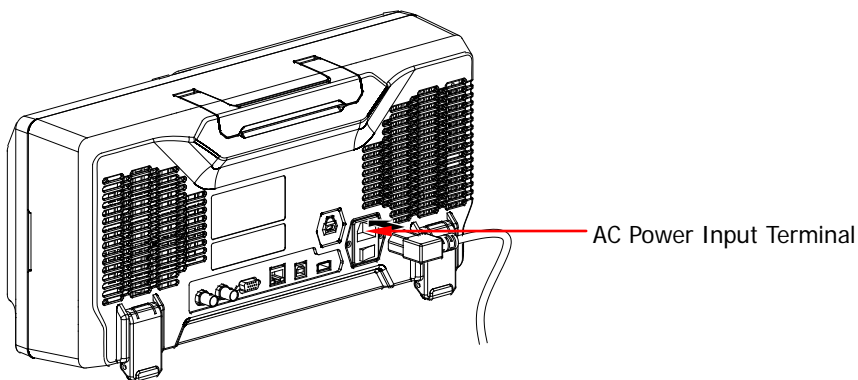



Figure 5 To Connect to AC Power Supply

Power-on Inspection

When the oscilloscope is energized, press the power key  at the lower-left corner of the front panel to start the oscilloscope. During the start-up process, the oscilloscope performs a series of self-tests and you can hear the sound of relay switching. After the self-test is finished, the welcome screen is displayed and you can view the Option Type, Option name, Option Edition and Left time of the option currently installed in the "Installed Options" pop-up dialog box on the screen. When the instrument is shipped, a trial version of the option is provided and the left time is about 2000 minutes. Press **Utility** → **System** → **SelfTestInfo** to view the self-test results.

To Connect the Probe

RIGOL provides passive and active probes for the MSO4000/DS4000 series oscilloscopes. For detailed technical information of the probes, please refer to the corresponding Probe User's Guide. The following are the probes recommended for this oscilloscope.

Model	Description
RP3500A	500 MHz, passive probe, standard, auto detection
RP7150	1.5 GHz, active probe, optional, auto detection

Connect the Probe:

1. Connect the BNC terminal of the probe to a channel BNC connector of the oscilloscope at the front panel.
2. Connect the probe tip to the circuit point under test and connect the ground alligator clip of the probe to the circuit ground terminal.

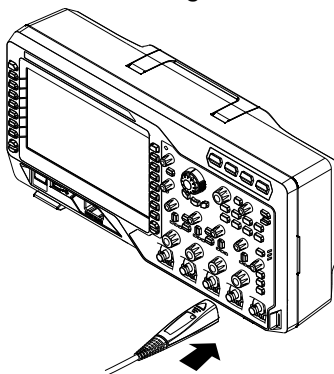

Figure 6 To Connect the Probe

Function Inspection

1. Press **Default** to restore the oscilloscope to its default configuration.
2. Connect the ground alligator clip of the probe to the "Ground Terminal" under the "Compensation Signal Output Terminal".
3. Connect the input terminal of CH1 of the oscilloscope with the "Compensation Signal Output Terminal" of the probe using the probe.

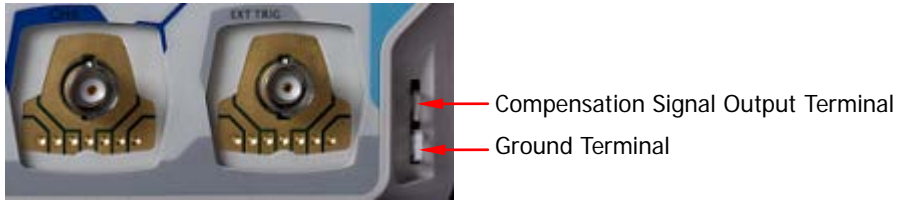

Figure 7 To Use the Compensation Signal

4. Press the **AUTO** key.
5. Observe the waveform on the display. In normal condition, the display should be a square waveform as shown in the figure below:

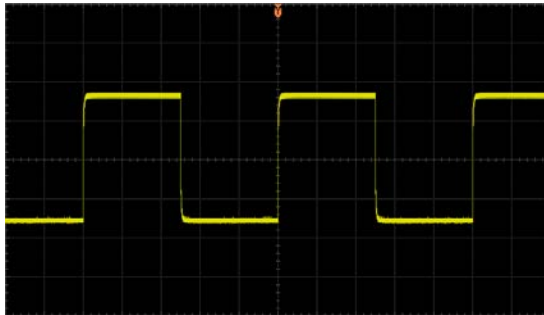

Figure 8 Square Waveform

6. Use the same method to test the other channels. If the square waveforms actually shown do not match that in the figure above, please perform **“Probe Compensation”** in the next section.



WARNING

To avoid electric shock during the use of probe, please make sure that the insulated wire of the probe is in good condition and do not touch the metallic part of the probe when the probe is connected to high voltage source.

Tip

The signal output from the probe compensation connector can only be used for probe compensation adjustment and can not be used for calibration.

Probe Compensation

When the probes are used for the first time, you should compensate the probes to match the input channels of the oscilloscope. Non-compensated or poorly compensated probes may cause measurement inaccuracy and error. The probe compensation procedure is as follows:

1. Perform step 1, 2, 3 and 4 of **"Function Inspection"** in the previous section.
2. Check the displayed waveforms and compare them with the following figures.



Over compensated

Perfectly compensated

Under compensated

Figure 9 Probe Compensation

3. Use a nonmetallic driver to adjust the variable capacitor on the probe until the displayed waveform is as the "Perfectly compensated" in the figure above.

To Connect the Logic Probe

RIGOL provides logic probe for the MSO4000 series digital oscilloscope. For detailed technical information of the logic probe, please refer to the corresponding Probe User's Guide.

Connect the logic probe single head to the digital channel input terminal [**LOGIC D0-D15**] at the front panel of the MSO4000 series digital oscilloscope. Note: connect the logic probe adaptor supplies with the accessories to the corresponding branch header (called channel group) before connecting the logic probe to the device under test.



Figure 10 To Connect the Logic Probe

Front Panel Overview

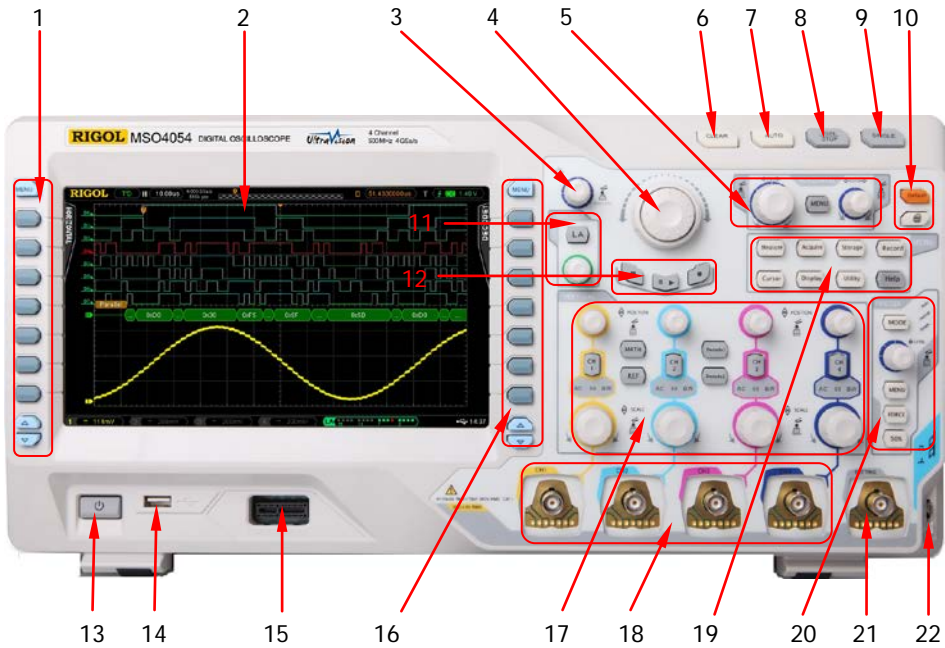

Figure 11 Front Panel Overview

Table 1 Front Panel Description

No.	Description	No.	Description
1	Menu	12	Record
2	LCD	13	Power Key
3	Knob	14	USB HOST
4	Navigation Knob	15	Digital Channel Input Terminal
5	HORIZONTAL	16	Function Setting Menu Softkeys
6	CLEAR	17	VERTICAL
7	AUTO	18	Analog Channel Input Terminals
8	RUN/STOP	19	Function Menu Keys
9	SINGLE	20	TRIGGER
10	Default&Print	21	EXT TRIG Input Terminal
11	LOGIC ANALYZER	22	Probe Compensation Signal Output Terminal/Ground Terminal

Rear Panel Overview

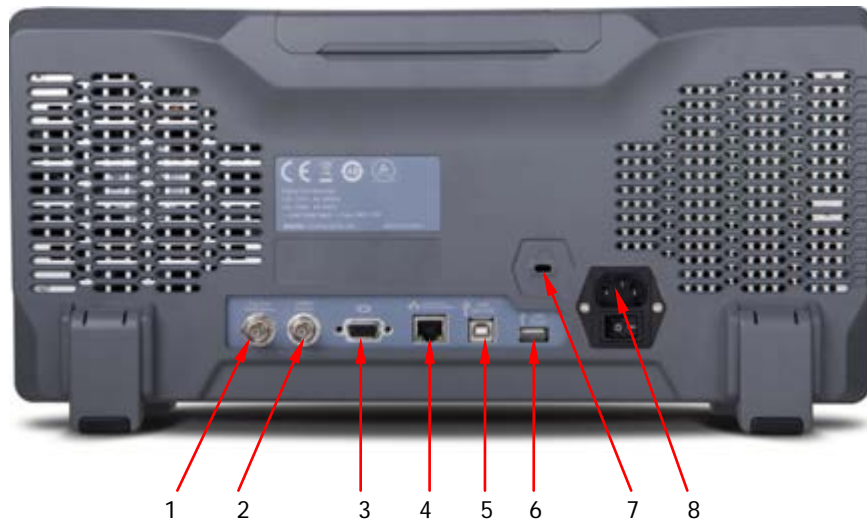

Figure 12 Rear Panel Overview

1. Trig Out/Calibration

Various kinds of signals can be output from this connector (press **Utility** → **AuxOutput** to select the desired output type).

- 1) **TrigOut:** the oscilloscope outputs a signal which can reflect the current capture rate of the oscilloscope each time a trigger is generated.
- 2) **Fast:** the oscilloscope outputs a fast edge signal which can be used in the self-calibration of the oscilloscope.
- 3) **GND:** the oscilloscope outputs a ground level.
- 4) **PassFail:** the oscilloscope outputs a pulse when failed waveform is detected and the pulse can be transmitted to other control system for easy view of the test result.

2. Reference Clock

Provide more precise sample clock signal for the oscilloscope and it can also synchronize two or more oscilloscope clocks.

3. Video Output

Through this interface, the oscilloscope can be connected to external monitors to get clearer waveform display. Note that the display of the oscilloscope is still valid.

4. LAN

Through this interface, the oscilloscope can be connected to the network for remote control. As the oscilloscope conforms to the LXI-C instrument standard, a test system can be built quickly and accessed through webpage.

5. USB DEVICE

Through this interface, the oscilloscope can be connected to the printer or PC to print data waveform or control the oscilloscope through PC software.

6. USB HOST

Through this interface, the oscilloscope can be connected to the printer to print waveform data or be connected to a USB storage device to store waveform files. GPIB interface communication can be realized by using the USB-GPIB interface converter provided by **RIGOL**.

Note that there is also a USB HOST interface at the front panel.

7. Lock Hole

Use the security lock (please buy it yourself) to lock the oscilloscope to a fixed location.

8. AC Input/Switch



AC power input terminal. The power supply requirements of this oscilloscope are 100-127 V, 45-440 Hz and 100-240 V, 45-65 Hz; CAT II. Please connect the oscilloscope to AC power using the power cord provided with the accessories. Then, turn on the AC power switch to energize the oscilloscope. Press the power key at the front panel to start the oscilloscope.

Front Panel Function Overview

VERTICAL

MSO4000/DS4000 provides independent vertical control systems for the four analog input channels.





- **CH1, CH2, CH3, CH4**: analog input channels. The four channels are marked by different colors which are also used to mark both the corresponding waveforms on the screen and the channel input connectors. Press any key to open the corresponding channel menu and press again to turn off the channel. AC: illuminated when AC channel coupling mode is enabled. 50: illuminated when the channel input impedance is 50 Ω . BW: illuminated when bandwidth limit is enabled.
- **MATH**: press this key to open the math operation menu under which add, subtract, multiply, divide operations, FFT operation, logic operation and advanced operation are provided.
- **REF**: press this key to enable the reference waveform function to compare the waveform actually tested with the reference waveform.
- **VERTICAL  POSITION**: vertical position knobs. During the modification, the position label at the lower left corner of the screen would change accordingly. Turn clockwise to increase the position and counterclockwise to decrease. Press down the knob to quickly reset the vertical position to zero.
- **VERTICAL  SCALE**: vertical scale knobs. During the modification, the scale label at the bottom of the screen would change accordingly. Turn clockwise to decrease the scale with a step of 5-2-1 and turn counterclockwise to increase

with a step of 1-2-5. Press down the knob to switch the vertical scale adjustment mode between “Coarse” and “Fine”.

- **Decode1** and **Decode2**: decoding function keys. Press the corresponding key to open the decoding function menu. MSO4000/DS4000 supports parallel decoding and protocol decoding.

HORIZONTAL



- **MENU**: press this key to open the horizontal control menu with which users can turn on or off the delayed sweep function, switch between different time base modes, switch between “Coarse” and “Fine” adjustments of scale as well as modify the horizontal reference setting.
- **HORIZONTAL  SCALE**: modify the horizontal time base. Turn clockwise to reduce the time base and turn counterclockwise to increase the time base. During the modification, waveforms of all the channels will be displayed in expanded or compressed mode and the time base message (e.g. **H < 200.0us**) at the upper side of the screen would change accordingly. Press down the knob to quickly switch to delayed sweep state.
- **HORIZONTAL  POSITION**: modify the trigger position. The trigger point would move left or right relative to the center of the screen when you turn the knob. During the modification, waveforms of all the channels would move left or right and the trigger position message (e.g. **D < 452.000000us**) at the upper-right corner of the screen would change accordingly. Press down the knob to quickly reset the trigger position (or the delayed sweep position)

TRIGGER



- **MODE**: press this key to switch the trigger mode to **Auto**, **Normal** or **Single** and the state backlight of the current trigger mode would be illuminated.
- **TRIGGER LEVEL**: modify the trigger level. Turn clockwise to increase the level and turn counterclockwise to reduce the level. During the modification, the trigger level line moves up and down and the value in the trigger level message box (e.g. **Trig Level 6.80 V**) at the lower-left corner of the screen would change accordingly. Press down the knob to quickly reset the trigger level to zero point.
- **MENU**: press this key to turn on the trigger operation menu. This oscilloscope provides various trigger types.
- **FORCE**: in **Normal** and **Single** trigger modes, press this key to generate a trigger signal forcefully.
- **50%**: press this key to set the trigger level to the vertical midpoint of the trigger signal amplitude.

CLEAR

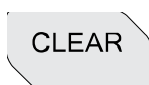

Press this key to clear all the waveforms on the screen. If the oscilloscope is in "Run" state, waveforms will still be displayed.

AUTO

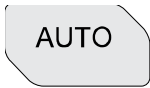

Press this key to enable the waveform auto setting function. The oscilloscope will automatically adjust the vertical scale, horizontal time base and trigger mode according to the input signal to realize optimum waveform display. Besides, quick parameter measurement function is also provided.

Note that auto setting requires that the frequency of the signal under test should be no lower than 50 Hz, the duty cycle be greater than 1% and the amplitude be at least 20 mVpp. If the parameters exceed these limits, "Auto failed" would be displayed after pressing this key and the quick parameter measurement menu might not be displayed.

RUN/STOP



Press this key to set the state of the oscilloscope to "Run" or "Stop". In "Run" state, the key is illuminated in yellow and red in "Stop" state.

SINGLE



Press this key to set the trigger mode to "Single". In single trigger mode, the oscilloscope triggers when the trigger condition is met and then stops.

Knob



This knob can be used to adjust the value of the parameters, adjust the waveform brightness and select the desired menu (the backlight turns on during the operation).

- During parameter input, turn the knob clockwise to increase the parameter and counterclockwise to decrease.
- When the menu blanks off, rotate the knob to adjust the waveform brightness. The adjustable range is from 0% to 100%. Turn the knob clockwise to increase the waveform brightness and counterclockwise to decrease. Press down the knob to reset the waveform brightness to 50%. Users can also press **Display** → **WaveIntensity** and then rotate the knob to adjust the waveform brightness.
- During menu operation, after pressing a menu softkey, rotate the knob to switch to the desired sub-menu under that menu and then press down the knob to select this sub-menu. You can also use it to modify parameter and input filename.

Navigation Knob



This knob provides quick Adjust/Locate function for numerical parameters with relatively larger settable ranges. Turn the knob clockwise (counter-clockwise) to increase (reduce) the value. Note that the inner knob is used for fine adjustment and the outer knob for coarse adjustment. The more the outer knob is rotated, the faster the value will change. For example, this knob can be used to quickly locate the waveform frame ("Current Frame" menu) to be played back in waveform playback. Similar menus include trigger holdoff, pulse width setting, slope time etc.

Default



Press this key to restore the oscilloscope to its default configuration.

Print

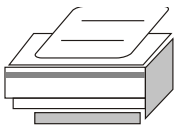

Press this key to execute print function or save the screen in the USB storage device. If the oscilloscope is currently connected to a printer and the printer is in idle state, press this key to execute print function. If no printer but a USB storage device is currently connected, press this key to save the screen to the USB storage device in ".bmp" format (if the current storage type is picture, the screen will be stored in the USB storage device in picture format). When printer and USB storage device are connected at the same time, the printer enjoys higher priority.

Function Keys



- **Measure**: press this key to enter the measurement setting menu to set the measurement-related parameters.
- **Acquire**: press this key to enter the sample setting menu to set the acquisition mode, the memory depth and the antialiasing function of the oscilloscope.
- **Storage**: press this key to enter the file store and recall interface. The storable file types include traces, waveforms, setups, picture and CSV. This instrument supports internal and external storage as well as disk management.
- **Cursor**: press this key to enter the cursor measurement menu. The oscilloscope

provides three cursor modes: manual, track and auto.

- **Display**: press this key to enter the display setting menu to set the display type, persistence time, wave intensity, grid type, grid brightness and menu display time of the waveform.
- **Utility**: press this key to enter the system function setting menu to set the system-related functions or parameters, such as I/O setting, sound and language. The oscilloscope also supports some advanced functions such as pass/fail test and print setting.
- **Record**: press this key to enter the waveform record menu. The oscilloscope provides waveform record function and supports record constant open mode as well as playback and analysis of recorded waveform.
- **Help**: press this key to open the help interface. For detailed information, please refer to the introduction in **“To Use the Built-in Help System”**.

Record



Stop Play/Pause Record

- **Record**: press this key to start recording the waveform. The backlight is illuminated in red. Besides, the backlight will also be illuminated when record constant on (open) mode is enabled.
- **Play/Pause**: in stop or pause state, press this key to play back the waveform and press again to pause the play. The backlight is illuminated in yellow.
- **Stop**: press this key to stop the waveform in record or playback mode. The backlight is illuminated in orange.

LOGIC ANALYZER



- **LA**: press this key to enter the logic analyzer setting interface. You can enable or disable groups of channels or a single channel, change the display size and the logic threshold of the digital channels and group the 16 digital channels and display them as a bus. You also can set a label for each digital channel.
- **LA** : this knob can be used to reposition the digital channels. Press this knob continuously to switch the digital channels currently enabled by the number of the digital channel (from small to large) and the channel selected is highlighted in red. Rotate the knob to move the digital waveform to desired position, press this knob again to fix this channel and select the next channel.

Note: this function is only available for MSO4000 series digital oscilloscope.

User Interface

MSO4000/DS4000 oscilloscope provides 9 inches, WVGA (800*480) 160,000 color TFT LCD. What is worth mentioning is that the 14-grid ultra-wide screen makes you view “longer” waveform.

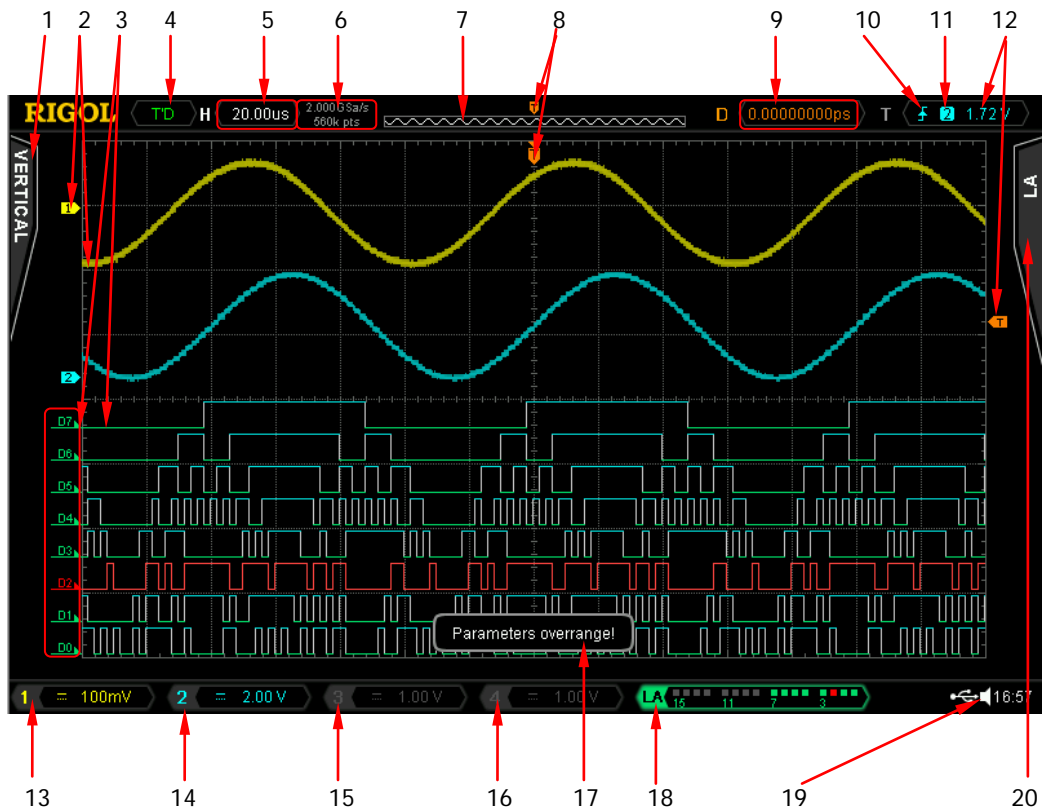

Figure 13 User Interface

1. Measurement Menu

Provide 12 horizontal (HORIZONTAL) and 12 vertical (VERTICAL) measurement parameters. Press the softkey at the left of the screen to activate corresponding measurement item.

2. Analog Channel Label/Waveform

Different channels are marked by different colors and the color of the waveform complies with the color of the channel.

3. Digital Channel Label/Waveform

The logic high levels of the digital waveforms are displayed in blue, the logic low levels are displayed in green which complies with the color of the digital channel label and the edges are displayed in white. Both the label and the waveform of the digital channel currently selected are displayed in red.

Note: this function is only available for MSO4000 series digital oscilloscope.

4. Status

Available states include RUN, STOP, T'D (triggered), WAIT and AUTO.

5. Horizontal Time Base

- Represent the time per grid on the horizontal axis on the screen.
- Use **HORIZONTAL**  **SCALE** to modify this parameter. The range available is from 1.000 ns to 1000 s.

6. Sample Rate/Memory Depth

- Display the current sample rate and memory depth of the oscilloscope.
- Use **HORIZONTAL**  **SCALE** to modify this parameter.

7. Waveform Memory

Provide the schematic diagram of the memory position of the waveform currently on the screen.

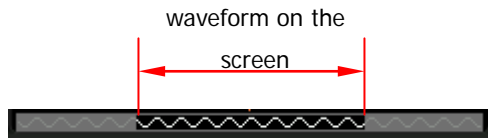

8. Trigger Position

Display the trigger position of the waveform in the waveform memory and on the screen.

9. Horizontal Position

Use **HORIZONTAL**  **POSITION** to modify this parameter. Press down the knob to automatically set the parameter to zero.

10. Trigger Type







Display the currently selected trigger type and trigger condition setting. Different labels are displayed when different trigger types are selected. For example:  represents triggering on the rising edge in "Edge" trigger.

11. Trigger Source





Display the trigger source (CH1-CH4, EXT, EXT/5, AC Line or D0-D15) currently selected. Different labels are displayed when different trigger sources are selected and the color of the trigger parameter area will change accordingly.

For example:  denotes that CH1 is selected as the trigger source.





12. Trigger Level/threshold

- The trigger level label  will be displayed at the right of the screen when the trigger source is selected CH1 to CH4 and the trigger level value is displayed at the upper-right corner of the screen. Note: in runt trigger and slope trigger, there are two trigger level labels ( and ).
- When Using **TRIGGER**  **LEVEL** to modify the trigger level, the trigger level value will change with the up and down of .
- There is no trigger level label  displayed when the trigger source is selected D0 to D15 and the trigger threshold is displayed at the upper-right corner of the screen (only available for MSO4000 series digital oscilloscope.).





13. CH1 Vertical Scale

- Display the voltage value per grid of CH1 waveform vertically.
- Use **VERTICAL**  **SCALE** to modify this parameter.
- The following labels will be provided according to the current channel setting: channel coupling (e.g.  in AC coupling), bandwidth limit (e.g.  when bandwidth limit is enabled) and input impedance (e.g.  when the input impedance is **50Ω**).

14. CH2 Vertical Scale



- Display the voltage value per grid of CH2 waveform vertically.
- Use **VERTICAL**  **SCALE** to modify this parameter.
- The following labels will be provided according to the current channel setting: channel coupling (e.g.  in AC coupling), bandwidth limit (e.g.  when bandwidth limit is enabled) and input impedance (e.g.  when the input impedance is **50Ω**).

15. CH3 Vertical Scale

- Display the voltage value per grid of CH3 waveform vertically.
- Use **VERTICAL**  **SCALE** to modify this parameter.
- The following labels will be provided according to the current channel setting: channel coupling (e.g.  in AC coupling), bandwidth limit (e.g.  when bandwidth limit is enabled) and input impedance (e.g.  when the input impedance is **50Ω**).

16. CH4 Vertical Scale

- Display the voltage value per grid of CH4 waveform vertically.
- Use **VERTICAL**  **SCALE** to modify this parameter.
- The following labels will be provided according to the current channel

setting: channel coupling (e.g.  in AC coupling), bandwidth limit (e.g.  when bandwidth limit is enabled) and input impedance (e.g.  when the input impedance is **50Ω**).

17. Message Box

Display prompt messages.



18. Digital Channel Status Area

Display the current state of the 16 digital channels. It is D0 to D15 from right to left. The digital channels currently enabled are displayed in green and the digital channel currently selected is highlighted in red. Any digital channel that is turned off will be grayed out in the Digital Channel Status Area.

Note: this function is only available for MSO4000 series digital oscilloscope.

19. Notification Area



Display system time, sound icon and USB storage device icon.

- System Time: displayed in "hh:mm (hour:minute)" format. When printing or storing the waveform, the output file will contain this time message. Press **Utility** → **System** → **System Time** to set the time in the following format:
yyyy-mm-dd hh-mm-ss (year-month-date hour-minute-second)
- Sound Icon: when sound is enabled,  is displayed. Press **Utility** → **Sound** to turn the sound on or off.
- USB Storage Device Icon: when the oscilloscope detects a USB storage device,  is displayed.



20. Operation Menu

Press any softkey to activate the corresponding menu. The following symbols might be displayed in the menu:



Denote that  at the front panel can be used to select parameter items. The backlight of  turns on when parameter selection is valid.



Denote that  can be used to modify parameter value. The backlight of  turns on when parameter input is valid.



Denote that you can use the navigation knob to quickly adjust/locate parameters.



Denote that users can rotate and then press down  to select the desired parameter.



Denote that the current menu has several options.



Denote that the current menu has a lower level menu.



Press this key to return to the previous menu.

Note that the following direction keys might appear in the grid at the lower-left corner of the menu bar:



Denote that you can open the next page menu.



Denote that you can open the previous page menu.

To Use the Security Lock

If needed, you can use the security lock (please buy it yourself) to lock the oscilloscope to a fixed location. The method is as follows, align the lock with the lock hole and plug it into the lock hole vertically, turn the key clockwise to lock the oscilloscope and then pull the key out.

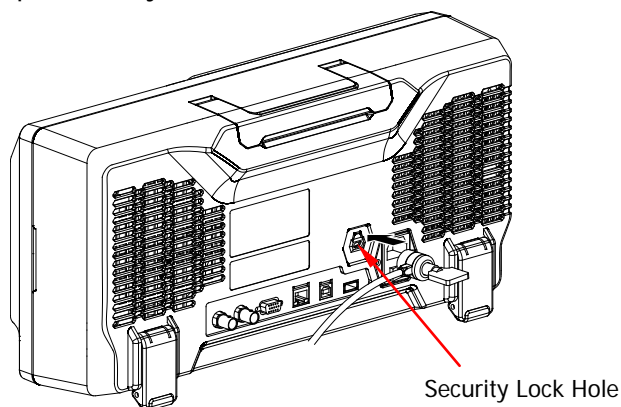

Figure 14 To Use the Security Lock

Note: do not insert other articles into the security lock hole to avoid damaging the instrument.

To Use the Built-in Help System

The help system of this oscilloscope provides instructions for all the function keys (including menu keys) at the front panel. Press **Help** to open the help interface and press again to close the interface. The help interface mainly consists of two parts. The left is “Help Options” and you can use “Button” or “Index” mode for selection. The right is “Help Display Area”.

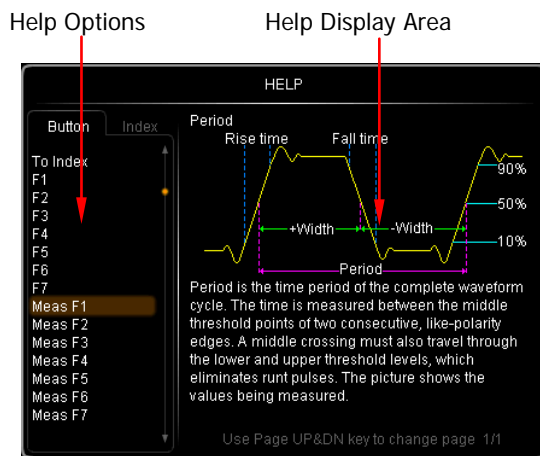







Figure 15 Help Information

Button:

Default mode. In this mode, you can press the button (except the power key , the knob  and menu page up/down key ) or rotate the knob at the front panel directly to get the corresponding help information of that button in the “Help Display Area”.

Use  to select “To Index” and then press down the knob to switch to **Index** mode.

Index:

In this mode, use  to select the item that needs to get help (for example: “Band Width”). The item currently selected is displayed with brown shading. Press down the knob to get the corresponding help information in the “Help Display Area”.

Use  to select “To Button” and then press down the knob to switch to **Button** mode.

Troubleshooting

The commonly encountered failures and their solutions are listed below. When you encounter those problems, please solve them following the corresponding steps. If the problem remains still, please contact **RIGOL** and provide your device information (acquisition method: **Utility** → **System** → **System Info**).

- 1. The screen is still dark (no display) after power on:**
 - (1) Check whether the power is correctly connected.
 - (2) Check whether the power switch is really on.
 - (3) Restart the instrument after finishing the above inspections.
 - (4) If it still does not work correctly, please contact **RIGOL**.

- 2. The signal is sampled but no waveform of the signal is displayed:**
 - (1) Check whether the probe is correctly connected to the signal connecting wire.
 - (2) Check whether the signal connecting wire is correctly connected to the BNC (namely channel connector).
 - (3) Check whether the probe is correctly connected to the item under test.
 - (4) Check whether there are signals generated from the item under test (you can connect the probe compensation output signal to the problematic channel to determine which has problems, the channel or the item under test).
 - (5) Resample the signal.

- 3. The tested voltage amplitude is greater or lower than the actual value (note that this problem usually occurs when probe is used):**

Check whether the attenuation coefficient of the channel complies with the attenuation ratio of the probe.

- 4. There is waveform display but not stable:**
 - (1) Check the trigger signal source: check whether the **Source** in the trigger menu complies with the signal channel actually used.
 - (2) Check the trigger type: general signals should use "Edge" trigger and video signal should use "Video" trigger. Only when the proper trigger type is used, can the waveform be displayed stably.

- (3) Try to change the **Coupling** to “HF Reject” or “LF Reject” to filter out the high-frequency or low-frequency noise that disturbs the trigger.
- (4) Change the trigger holdoff setting.

5. No display after pressing **RUN/STOP:**

Check whether the **MODE** at the trigger panel (TRIGGER) is “Normal” or “Single” and whether the trigger level exceeds the waveform range. If yes, set the trigger level to the middle or set the **MODE** to “Auto”.

Note that using the **AUTO** button could automatically finish the above setting.

6. The display of waveform is ladder-like:

- (1) The horizontal time base might be too low. Increase the horizontal time base to increase the horizontal resolution and improve the display.
- (2) If the display **Type** is “Vectors”, the lines between the sample points may cause ladder-like display. Set **Type** to “Dots” to solve the problem.

7. Fail to connect PC or printer through USB:

Check the **IO Setting** menu in **Utility** to make sure whether the setting in **USB Device** matches the currently connected device. If needed, restart the oscilloscope.

8. The USB storage device can not be recognized:

- (1) Check whether the USB storage device can work normally.
- (2) Make sure that the USB storage device used is flash storage type. This oscilloscope does not support hardware storage type.
- (3) Make sure whether the capacity of the USB storage device is too large. It is recommended that the capacity of the USB storage device being used with this oscilloscope is no larger than 8 GBytes.
- (4) Restart the instrument and then insert the USB storage device.
- (5) If the USB storage device still can not be used normally, please contact **RIGOL**.